

VSH-10Z

10KV photo ionizer head.

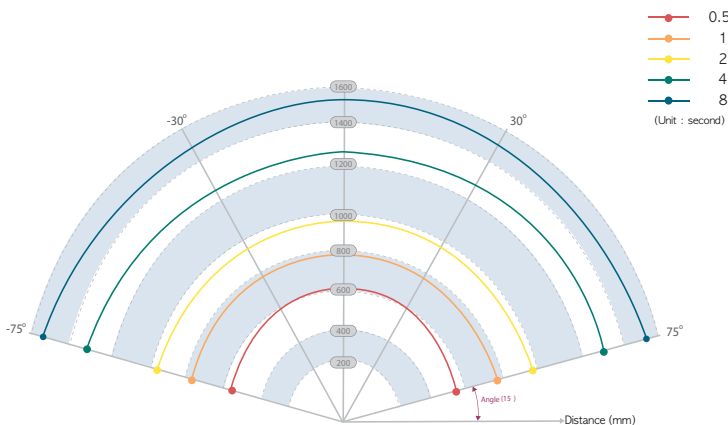

• Ionization Performance According To Distance



• Specification

Tube voltage(DC)	11 kV
Beam angle	150°
Power input	DC 12V
MAX consumption	8 W
Weight	0.3 kg

• How does soft X-Ray ionizer work?

The principle behind soft x-ray static elimination is the use of air ionization of soft x-rays. Soft x-rays are easily absorbed within the atmosphere to generate positive and negative ions. These positive and negative ions move being pulled according to the electrical charge of the electrified object according to coulomb's force and ultimately meeting with the electrified charge to become neutralized. Different from corona discharge type, soft x-ray, a form of light, is used and is suitable for use in clean rooms as peeling of metal is caused by ion collisions due to discharge does not occur.

• Advantages of soft X Ray ionizer

Perfect ion balance

Unlike corona discharge electrodes that use high-pressure negative electrons, it equally generates positive and negative ions by using soft x ray, in turn enabling even ionization capacities unrelated to surface charge polarity.

No occurrence of metal dust

It is suitable for use in clean rooms highly sensitive to contamination as metal dusts are not generated as corona discharge electrodes are not used. It also prevents product defects caused by metal dust and requires minimal maintenance costs compared to corona discharge electrode.

Fast ionization speeds

Faster ionization speeds compared to corona discharge types based on high ionization density.

No occurrence of ozone

Unlike corona discharge that provides ozone (strong oxidizing gas) in atmospheric discharges, it has no atmospheric discharge, in turn preventing harmful health effects and corrosion of equipment.

• Environmental

Operation temperature	0~40°C
Storage temperature	-10°C~60°C
Operation humidity	Less than 60%
Storage humidity	Less than 85%

○ Head office

ADDRESS: [28182]151-33, Namseokro, Namyi-myeon, Seowon-gu, Cheongju-si, Chungcheongbuk-do, Korea
 TEL: +82-43-267-9039 FAX: +82-43-269-4039 E-MAIL: sales @ vsi.co.kr

○ Factory

ADDRESS: [30067] 328, Songam-ro, Yeondong-myeon, Sejong-si
 TEL: +82-44-868-9041 FAX: +82-43-269-4039



Product Details

VSC-104Z (Controller)

● Specification

Power input	100~240V, 50/61Hz
MAX consumption	56 W
Weight	0.65 kg
I/O Interface	Remote, Interlock, Fail
Serial communication	RS-485
I/O Pin Connector	DSUB15P Female

Photo ionizer controller. It can control maximum 4units of X-Ray head.



● Radiation Material

Shield material	Material thickness
Stainless steel	0.2
Aluminum	3
glass	5
PVC	4
Acrylic	46



● Composition

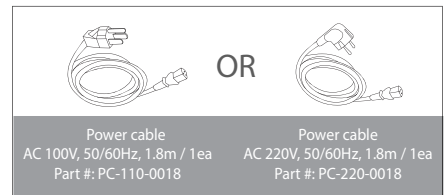
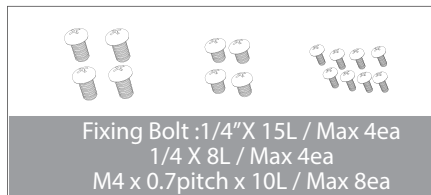
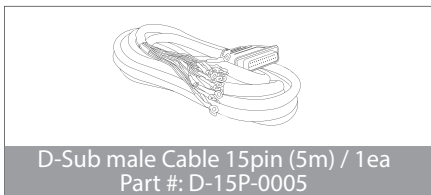
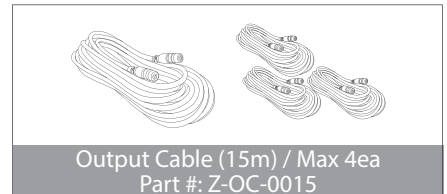
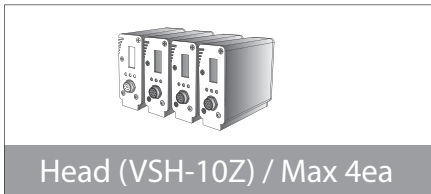

● Dimensions (unit:mm)

Head

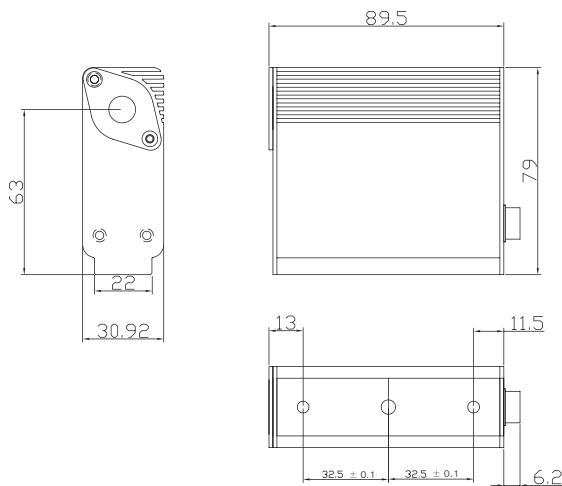

Controller

